



293 Wright Street, Delavan, WI 53115
 Phone: 1-800-365-6832
 Fax: 1-800-526-3757
 Web Site: flotecwater.com

OWNER'S MANUAL

Submersible Sump Pumps

NOTICE D'UTILISATION

**Pompes submersibles
pour puisard**

MANUAL DEL USUARIO

**Bombas sumergibles
para sumideros**

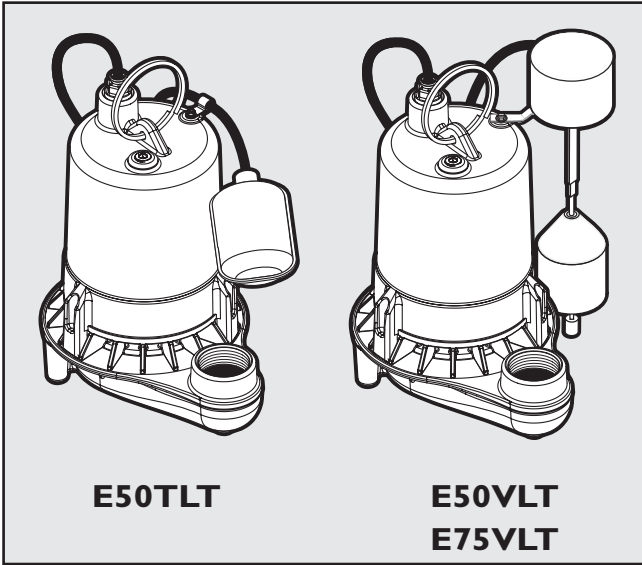

E50TLT

**E50VLT
E75VLT**

Installation/Operation/Parts

*For further operating,
installation, or maintenance
assistance:*

Call 1-800-365-6832

English..... Pages 2-9

Installation/Fonctionnement/Pièces

*Pour plus de renseignements
concernant l'utilisation,
l'installation ou l'entretien,*

Composer le 1 (800) 365-6832

Français Pages 10-17

Instalación/Operación/Piezas

*Para mayor información sobre el
funcionamiento, instalación o
mantenimiento de la bomba:*

Llame al 1-800-365-6832

Español.....Paginas 18-25

General Safety Information

Your automatic sump pump should give years of trouble-free service when correctly installed, maintained, and used. However, interruption of power to the pump, dirt/debris in the sump, flooding that exceeds the pump's capacity, electrical or mechanical failure in the pump, etc., may prevent normal pump operation. To help prevent damage from flooding, purchase a secondary AC sump pump, a DC backup sump pump, and/or a high water alarm. See Troubleshooting in this manual for information about common sump pump problems and remedies. For more information, call Flotec customer service at 1-800-365-6832 or visit our website at FlotecWater.com.

⚠️ WARNING Risk of electric shock. Can shock, burn or kill. To reduce the risk of hazardous or fatal electrical shock, follow instructions A through D, below:

- A. This pump has an approved 3-conductor power cord with 3-prong, grounding-type plug. Connect the pump only to a properly grounded, 3-prong outlet. If the sump pump circuit has a 2-prong outlet, replace it with a grounded 3-prong outlet installed according to code.
B. Unplug the pump before handling or servicing it. If your basement floor is wet, turn off all power before walking on it. If the shut-off box is in the basement, call your electric company or hydro authority to shut off service to the house, or call your local fire department for instructions. After turning off the power, remove the pump for service.
C. Protect the electrical cords from sharp objects, hot surfaces, oil, and chemicals. Avoid kinking the cords. Replace damaged or worn cords.
D. Do not lift the pump by the power cord.

⚠️ WARNING Risk of fire. Plastic pipe glue is extremely flammable. Follow the glue manufacturer's instructions when assembling glued plastic pipe.

⚠️ CAUTION Risk of burns. Motors may run hot. Allow 20 minutes to cool before handling.

- 1. Know the pump application, limitations, and potential hazards.
2. Do not use this pump in water with fish present. If any oil leaks out of the motor it can kill fish.
3. Drain the system completely before servicing it.
4. To prevent a flexible discharge line from whipping, which could cause injury or damage, fasten it down before starting the pump.
5. Before each use, check any hoses in the system for weakness or wear. Make certain that all connections are tight.

- 6. Periodically inspect the sump, the pump, and the piping for debris and foreign objects. Perform routine cleaning as required.
7. Personal Safety:
a. Wear safety glasses at all times when working with pumps.
b. Keep your work area clean, uncluttered and properly lighted; put away all unused tools and equipment.
c. Keep visitors at a safe distance from the work area.
d. Make workshop child-proof with padlocks and master switches. Remove any starter keys.
8. This pump installation must meet all applicable laws, codes, and ordinances.

California Proposition 65 Warning

⚠️ WARNING This product and related accessories contain chemicals known to the State of California to cause cancer, birth defects or other reproductive harm.

Specifications

Power supply 115V, 60 HZ., 15 Amp Circuit
Liquid Temp. Range..... 32°F to 70°F(0°-21°C)
Individual Branch Circuit Required (min.)15 Amps
Discharge:1-1/2" Female NPT

This pump is designed for use in a residential sump only. Pump water only with this pump.

NOTICE: This unit is not designed as a waterfall or fountain pump, or for applications involving salt water or brine! Use with waterfalls, fountains, salt water or brine will void warranty. Do not use where water recirculates.

Not designed for use as a swimming pool drainer.

NOTICE: Read this owner's manual for installation, operation, and safety information.

Tools Required:

- Pipe wrench, Strap Wrench, or Slip-Joint Pliers,
Hacksaw,
Screw Driver,
File or Sandpaper

Materials Required:

- 1-1/2" ABS or PVC Pipe with Cement to match Threaded Adapter (Pipe to Pump)
Check Valve – Purchase a FP0026-10 (goes in the discharge line) or FP0026-6D (goes in the pump discharge). If your check valve does not have an 1/8" anti-airlock hole, drill one in the discharge pipe just above where it screws into the pump discharge. Be sure to install the check valve so that the flow will be away from the pump.

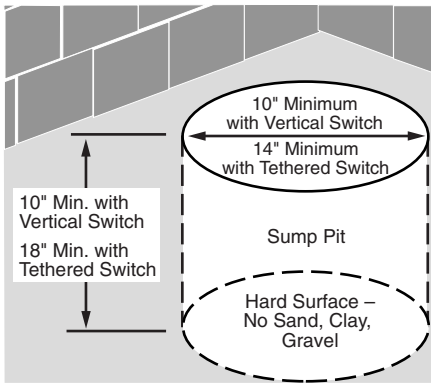
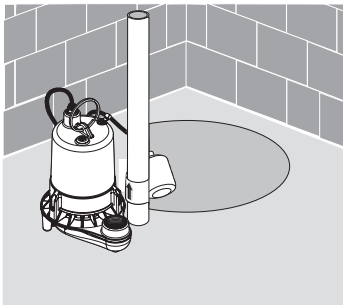

Figure 1

- 1A. Minimum sump size: 10" (254mm) diameter by 10" (254mm) depth for vertical switch models; 14" (356mm) diameter by 18" (457mm) depth for tethered switch models.
- 1B. Construct the sump pit of tile, concrete, steel, or plastic; it must meet code requirements.
- 1C. No clay, earth, sand, or gravel in the sump (they will clog the pump). Keep the pump inlet screen clear.



6201 0410

Figure 2

- 2A. Install the discharge plumbing and check valve, using PTFE pipe thread sealant tape - NOT pipe joint compound.
- 2B. Tighten the pipe into the pump (hand tight + 1-1/2 turns).
- 2C. Install a check valve in the vertical pipe to prevent flow backwards through the pump when it shuts off. To prevent airlocking the pump, drill a 1/8" (3.2 mm) hole in the discharge pipe just above where it screws into the pump discharge. Install the check valve above this hole, but keep it as close to the pump as possible. Be sure the hole is below the waterline and below the check valve.

- 2D. To reduce noise and vibration, cut the discharge pipe near the pump and fasten a short length of rubber hose (1-7/8" (48 mm) I.D., e.g. radiator hose) into it with hose clamps.
3. Place the pump in the sump; make sure that nothing interferes with switch operation. For tethered switch models, the tether length should be 3-1/2" (See Figure 3).

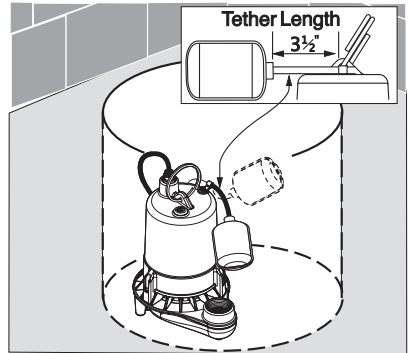

Figure 3

4. Finish installing the necessary plumbing. Follow the glue manufacturer's instructions for safety precautions and curing time.

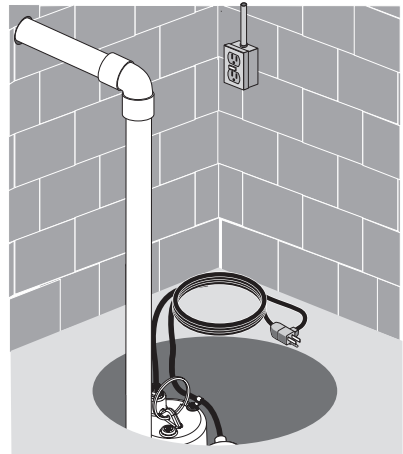

Figure 4

⚠ CAUTION Risk of flooding. Make sure the pump cannot move in the sump. If the pump moves when it runs, the piping or sump wall may interfere with the switch and prevent the pump from starting or stopping.

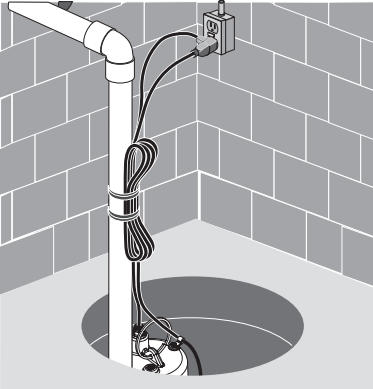

Figure 5

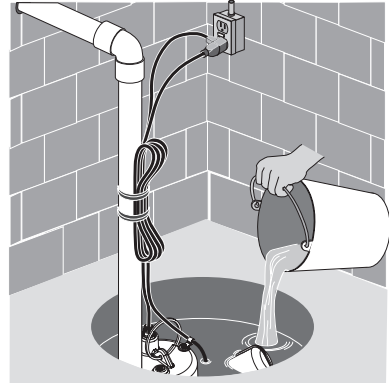

Figure 6

5. **Power Supply:** This pump requires a 115 V., 60 Hz., 15 amp individual branch circuit. The circuit must be grounded and should be dedicated to the sump pump. The pump is supplied with a 3-wire cord set with grounding-type plug. Plug the switch directly into the outlet and plug the pump into the opposite end of the switch's plug.

⚠ WARNING Risk of electric shock. Can shock, burn or kill. Always ground the pump to a suitable electrical ground, such as a grounded water pipe, a properly grounded metallic raceway, or a ground wire system. Do not cut off the round ground pin.

6. After you have installed the piping, check valve, and float switch, the pump is ready for operation. Check the pump by filling the sump with water and observing the pump's operation through one complete cycle. For switch settings see *Electrical and Switch Specifications*.

⚠ CAUTION Risk of flooding. Failure to make this operational check may lead to improper operation, premature failure, and flooding.

1. The shaft seal depends on water for lubrication. Do not operate the pump unless it is submerged in water; running it dry may damage the seal.
2. If the pump overheats, an automatic-reset thermal protector cuts off the power and stops the motor before it can be damaged. The motor will automatically restart when it cools. If the protector trips repeatedly, unplug the pump, remove it from the sump, and check it for the cause of the difficulty. Low voltage, long extension cords, clogged impeller, very low lift, a plugged or frozen discharge pipe, etc., can all cause cycling and overheating.
3. This pump will not remove all the water in the sump. If you are running the pump manually and water stops coming out of the discharge, the pump has probably run dry. Shut it off immediately and check the water level.

Performance

GPH At Total Feet Of Lift					No flow at height shown below
Model	5 ft.	10 ft.	15 ft.	20 ft.	
Capacity Gallons/Hour					22'
E50TLT	4,320	3,660	2,640	1,020	
E50VLT	4,320	3,660	2,640	1,020	
E75VLT	4,800	4,020	3,180	1,800	25'

Electrical & Switch Specifications

Model	Motor HP	Motor Full Load Amps	Individual Branch Circuit Req. (Amps)	*Switch Setting in inches Water Level For:	
				On	Off
E50TLT	1/2	6.9	15	13-1/2"	4-1/2"
E50VLT				7-1/2"	3"
E75VLT	3/4	7.0			

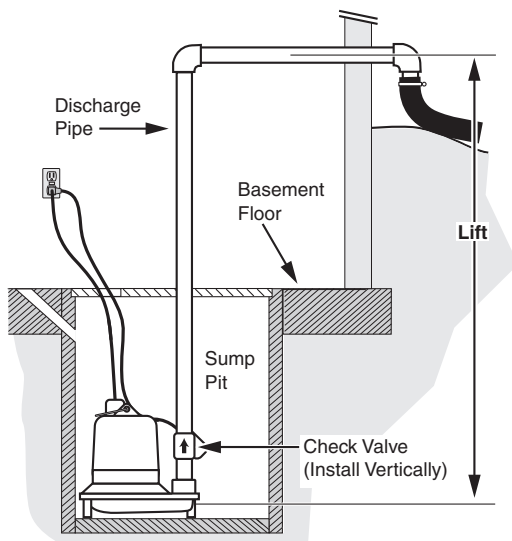
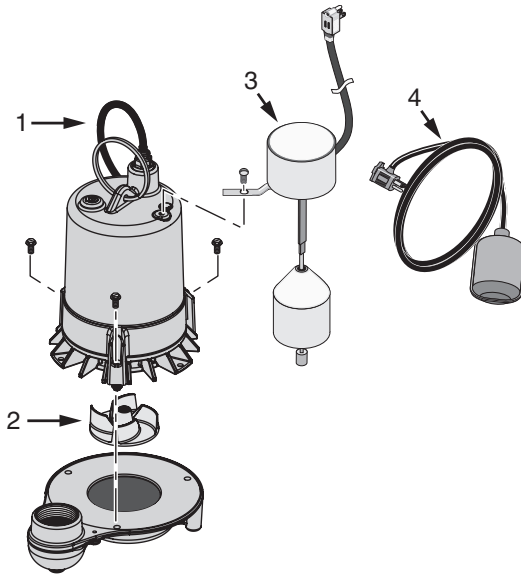

Figure 7 – LIFT: Lift is the vertical distance the pump actually lifts water. The higher the lift, the lower the flow.

NOTICE The friction caused by water running through the pipe will also, on longer pipe runs, reduce the flow. Pipe smaller than the pump discharge also reduces flow.

E50TLT
E50VLT
E75VLT



Ref.	Part Description	Qty.	E50TLT	E50VLT	E75VLT
1	Power Cord Assembly	1	PW117-281-TSU		
2	Impeller†	1	PS5-33P		PS5-34P
3	Vertical Float Switch Ass'y	1	-	PKG208	
4	Tethered Float Switch Ass'y	1	FP18-15BD	-	

NOTICE If motor fails, replace entire pump.
† See Page 8 for impeller replacement instructions.

⚠ WARNING Risk of electrical shock. Unplug the pump before touching it or servicing it.

Symptom	Probable Cause(s)	Corrective Action
Pump won't start or run.	Pump is not plugged in.	Make sure the pump is plugged into a proper outlet.
	Blown fuse.	Replace the fuse with a fuse of proper size.
	Low line voltage.	Check the size of the wiring on the circuit feeding the pump and from the main switch on the property. If everything is OK, contact your power company or hydro authority.
	Defective motor.	Replace the pump.
	Defective float switch.	Replace the float switch.
Pump starts and stops too often.	Clogged or jammed Impeller.	If the impeller won't turn, unplug the pump, remove the lower pump body, and locate the source of the binding. Replace the impeller if necessary.
	Backflow of water from piping.	Install or replace the check valve.
Pump won't shut off.	Faulty switch.	Replace the switch.
	Defective switch.	Replace the switch, after first checking that switch is functional.
	Restricted discharge (obstacle or ice in the piping).	Unplug the pump, remove it from the sump, and clean the pump and piping.
Pump operates but delivers little or no water.	Restricted intake screen.	Unplug the pump, remove it from the sump, and clean the intake screen and impeller.
	Low line voltage.	If the voltage is below 110 volts, check the size of the wiring from the main switch on the property. If OK, contact your power company or hydro authority.
	Debris caught in the impeller.	Remove the pump and clean out the impeller.
	Worn or defective parts or plugged impeller.	Clean the impeller if it's plugged; replace the impeller if necessary; otherwise replace the pump.
	Check valve installed without vent hole	Drill a 1/8" (3mm) dia. hole between the pump discharge and the check valve (1-2" above the pump discharge and below the waterline).
	Restricted intake screen.	Remove the pump and clean out the intake screen.
Check valve is installed either backward or upside down.	Be sure the check valve is installed correctly (the flow arrow should point away from the pump).	

First: Turn off power to the pump, disconnect the discharge piping, and lift the pump out of the sump **BY THE HANDLE ON TOP OF THE MOTOR** (not by the cord).

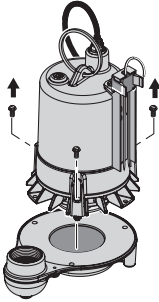

Step 1: Remove the three screws holding the motor to the base and lift the motor off the base.

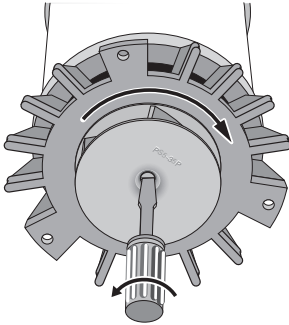

Step 2: Hold the motor shaft with a screwdriver and unscrew the impeller as shown.

NOTICE: The impeller has a left-hand thread, so it loosens to the right (↺).

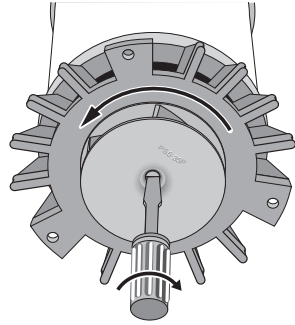

Step 3: Thread the new impeller onto the motor shaft as shown (left-hand thread – tightens to the left ↺).

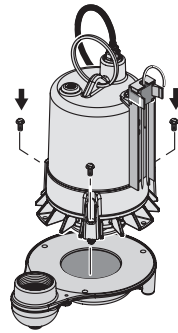

Step 4: Re-mount the motor on the base. Be sure to mount it so that the switch is clear of the discharge and all other obstructions in the sump.

Last: Run the pump through one complete cycle after it is assembled and reinstalled. It should operate correctly and you should not hear any sounds of scraping or dragging from the pump.

Retain Original Receipt For Warranty Eligibility

Limited Warranty

This Limited Warranty is effective June 1, 2011 and replaces all undated warranties and warranties dated before June 1, 2011. FLOTEC warrants to the original consumer purchaser ("Purchaser" or "You") that its products are free from defects in material and workmanship for a period of twelve (12) months from the date of the original consumer purchase. If, within twelve (12) months from the original consumer purchase, any such product shall prove to be defective, it shall be repaired or replaced at FLOTEC's option, subject to the terms and conditions set forth herein. Note that this limited warranty applies to manufacturing defects only and not to ordinary wear and tear. All mechanical devices need periodic parts and service to perform well. This limited warranty does not cover repair when normal use has exhausted the life of a part or the equipment.

The original purchase receipt and product warranty information label are required to determine warranty eligibility. Eligibility is based on purchase date of original product – not the date of replacement under warranty. The warranty is limited to repair or replacement of original purchased product only, not replacement product (i.e. one warranty replacement allowed per purchase). Purchaser pays all removal, installation, labor, shipping, and incidental charges.

For parts or troubleshooting assistance, DO NOT return product to your retail store - contact FLOTEC Customer Service at 1-800-365-6832.

Claims made under this warranty shall be made by returning the product (except sewage pumps, see below) to the retail outlet where it was purchased or to the factory immediately after the discovery of any alleged defect. FLOTEC will subsequently take corrective action as promptly as reasonably possible. No requests for service will be accepted if received more than 30 days after the warranty expires. Warranty is not transferable and does not apply to products used in commercial/rental applications.

Sewage Pumps

DO NOT return a sewage pump (that has been installed) to your retail store. Contact FLOTEC Customer Service. Sewage pumps that have seen service and been removed carry a contamination hazard with them.

If your sewage pump has failed:

- Wear rubber gloves when handling the pump;
• For warranty purposes, return the pump's cord tag and original receipt of purchase to the retail store;
• Dispose of the pump according to local disposal ordinances.

Exceptions to the Twelve (12) Month Limited Warranty

Table with 2 columns: Product - Model and Warranty Period. Rows include FPOF360AC, FPOFDC (90 days); FPOS1775A, FPOS1790PCA, FPOS2400A, FPOS2450A, FPOS4100X, FP2800DCC, FPCP-20ULST, FPPSS3000, FPSC2150A, FPSC3150A, FPSC3350A (2 Years); 4" Submersible Well Pumps, FPOS3200A, FPOS3250A, FPOS6000A, FPSC1725X, FPSC2200A, FPSC2250A, FPSE3601A, FPPSS5000 (3 Years); FP7100 Series Pressure Tanks, E100ELT, E3305TLT, E3375TLT, E5005TLTT, E50TLT, E50VLT, E75STVT, E75VLT, FPSC3200A, FPSC3250A, FPSC4550A (5 Years).

General Terms and Conditions; Limitation of Remedies

You must pay all labor and shipping charges necessary to replace product covered by this warranty. This warranty does not apply to the following: (1) acts of God; (2) products which, in FLOTEC's sole judgment, have been subject to negligence, abuse, accident, misapplication, tampering, or alteration; (3) failures due to improper installation, operation, maintenance or storage; (4) atypical or unapproved application, use or service; (5) failures caused by corrosion, rust or other foreign materials in the system, or operation at pressures in excess of recommended maximums.

This warranty sets forth FLOTEC's sole obligation and purchaser's exclusive remedy for defective products.

FLOTEC SHALL NOT BE LIABLE FOR ANY CONSEQUENTIAL, INCIDENTAL, OR CONTINGENT DAMAGES WHATSOEVER.

THE FOREGOING LIMITED WARRANTIES ARE EXCLUSIVE AND IN LIEU OF ALL OTHER EXPRESS AND IMPLIED WARRANTIES, INCLUDING BUT NOT LIMITED TO IMPLIED WARRANTIES OF MERCHANTABILITY AND FITNESS FOR A PARTICULAR PURPOSE. THE FOREGOING LIMITED WARRANTIES SHALL NOT EXTEND BEYOND THE DURATION PROVIDED HEREIN.

Some states do not allow the exclusion or limitation of incidental or consequential damages or limitations on how long an implied warranty lasts, so the above limitations or exclusions may not apply to You. This warranty gives You specific legal rights and You may also have other rights which vary from state to state.

FLOTEC • 293 Wright Street • Delavan, WI U.S.A. 53115
Phone: 1-800-365-6832 • Fax: 1-800-526-3757 • Web Site: FlotecWater.com